

Plik powinien mieć spady - 2mm na stronę
Odległość ważnych elementów od krawędzi noża - 3mm

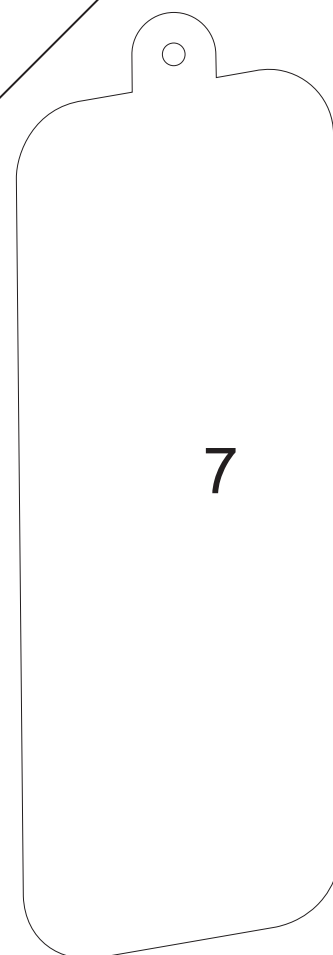

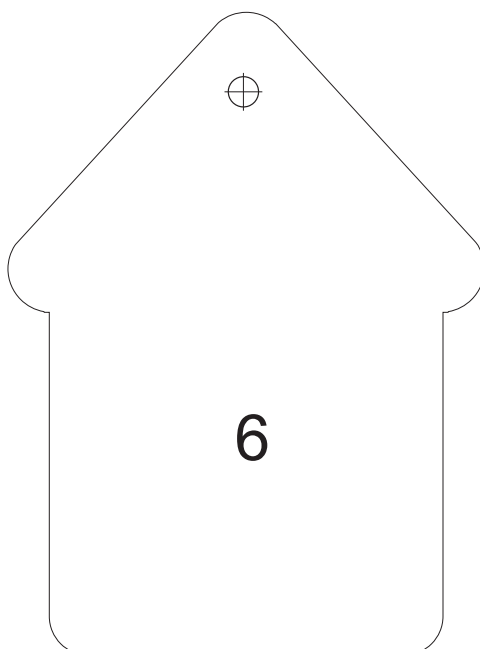

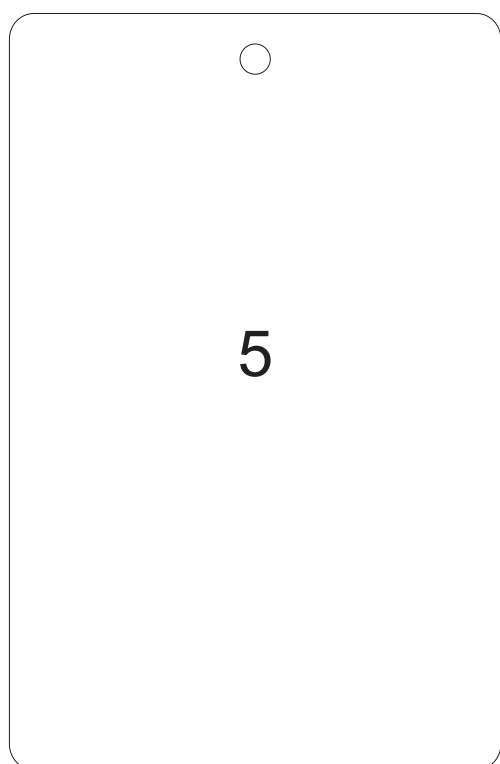

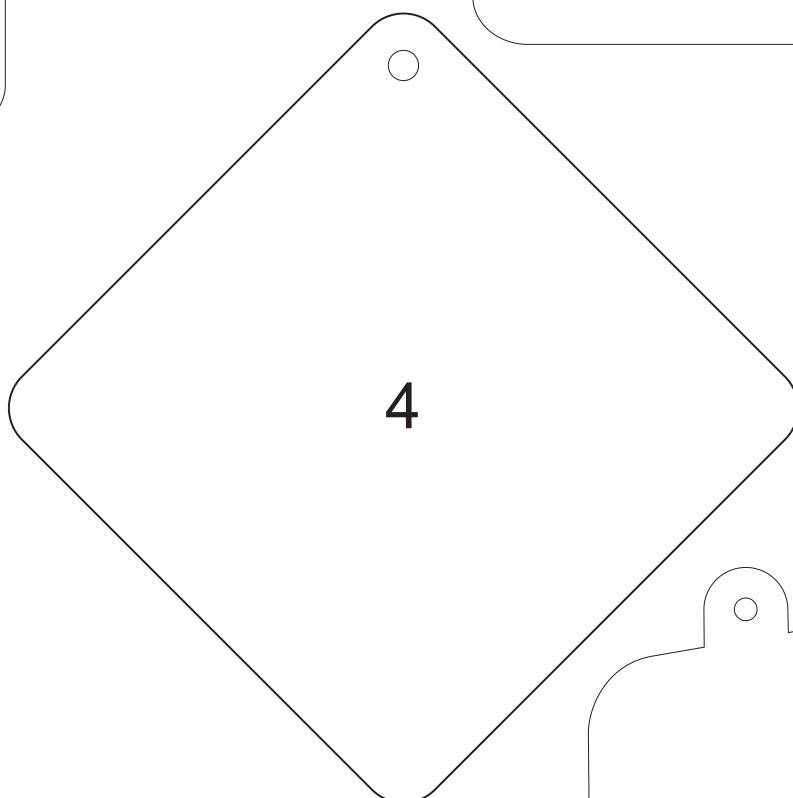
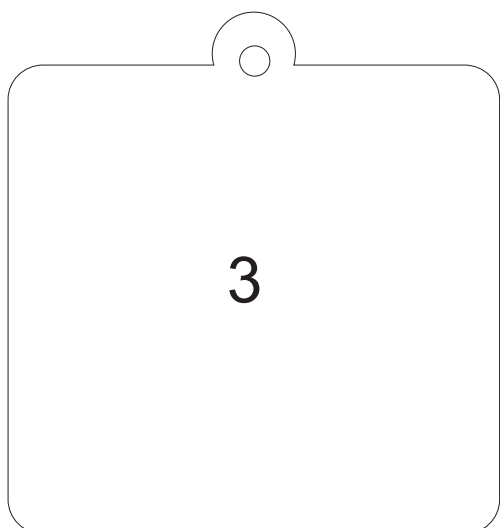
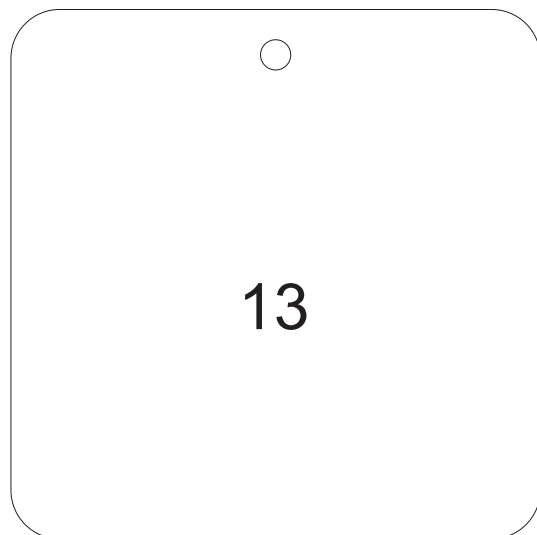
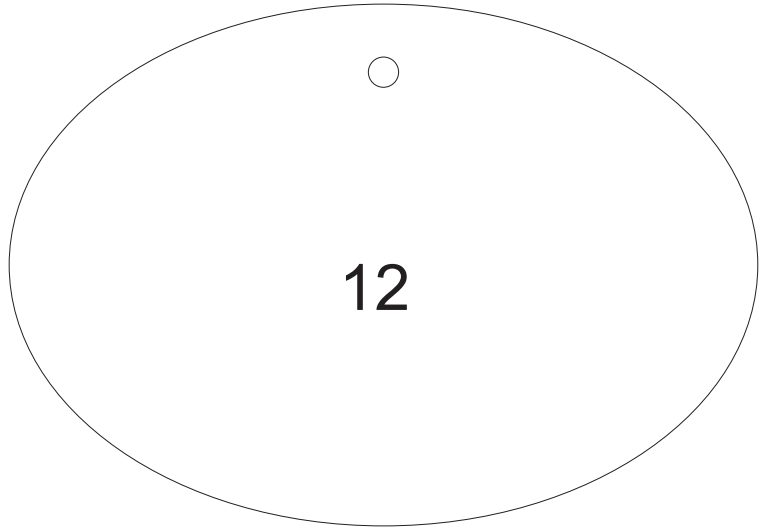
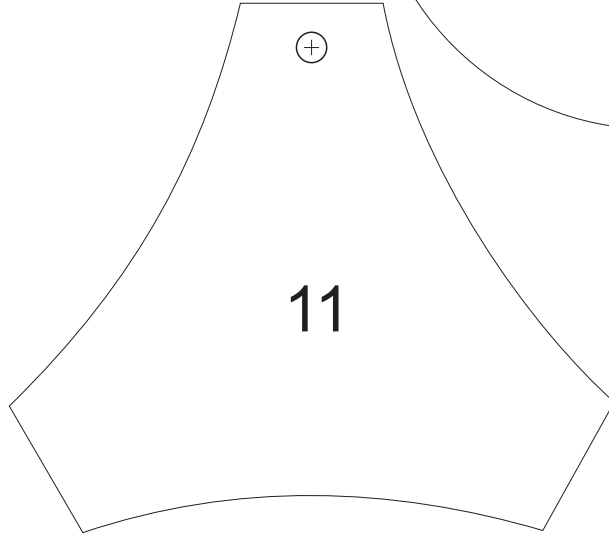
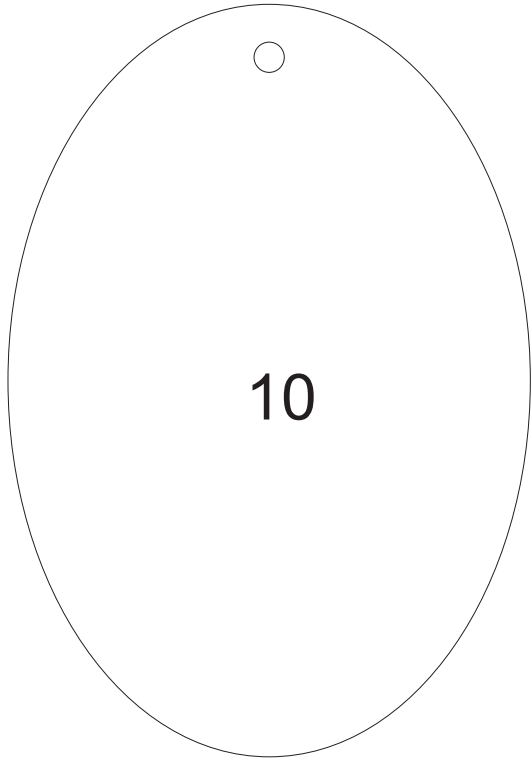
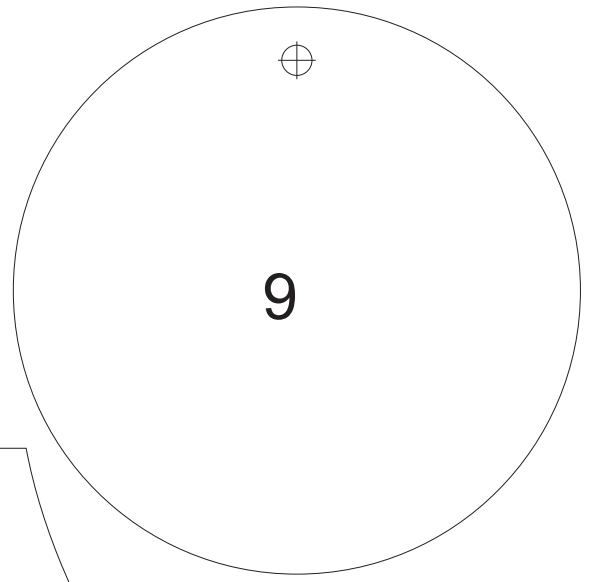
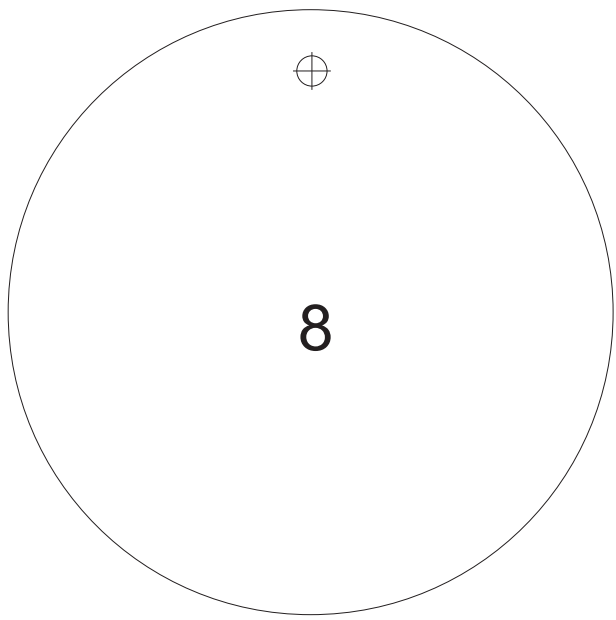
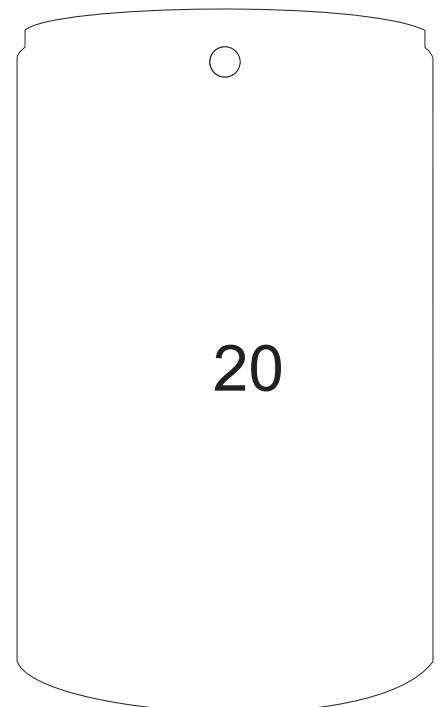
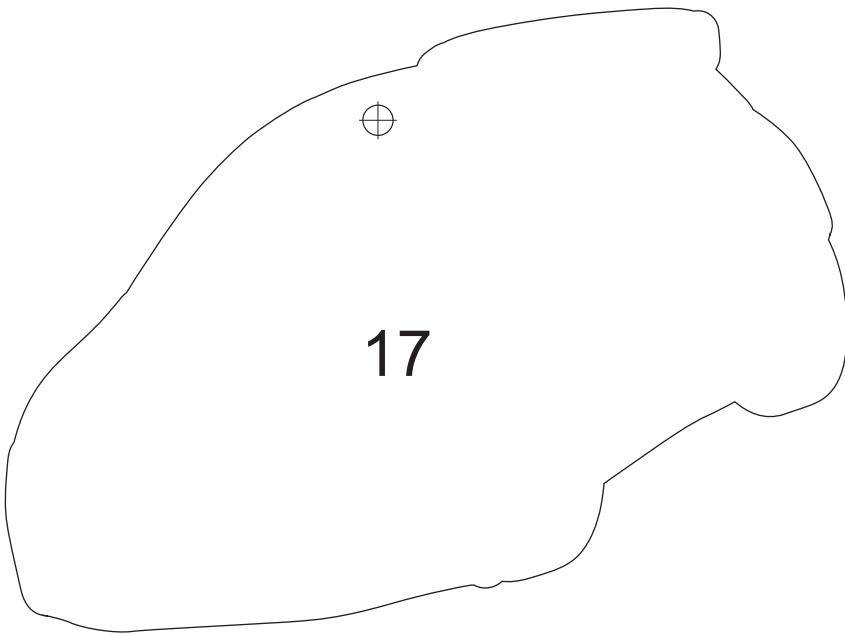
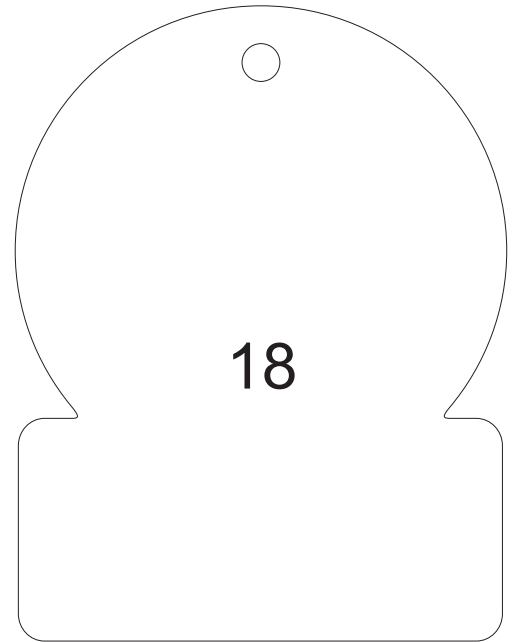
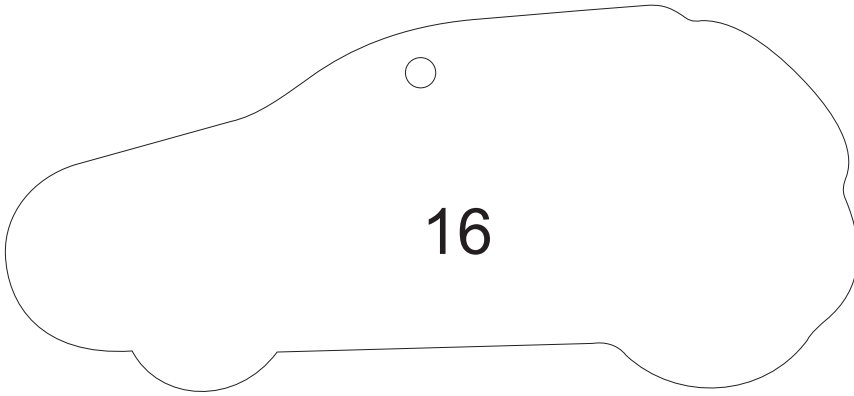
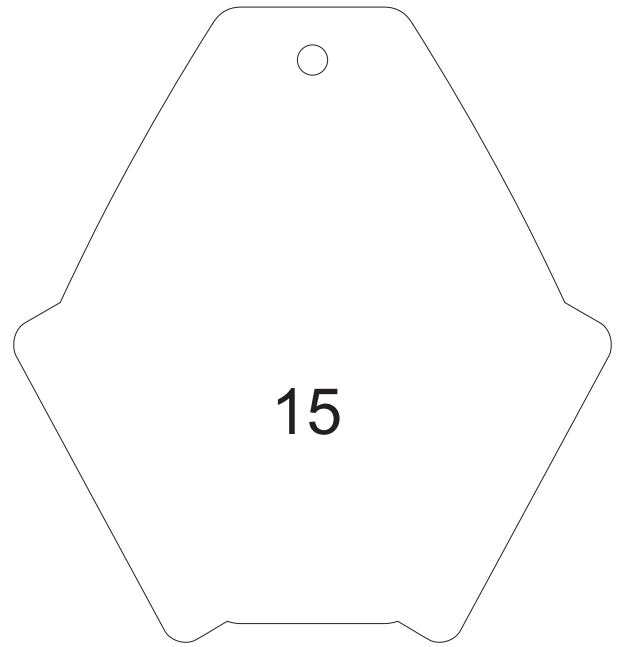
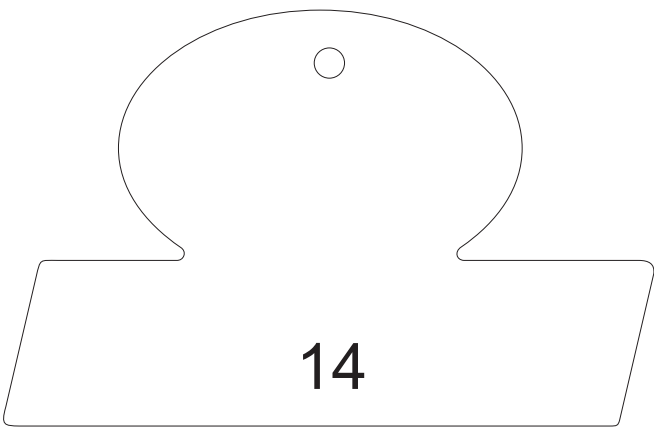
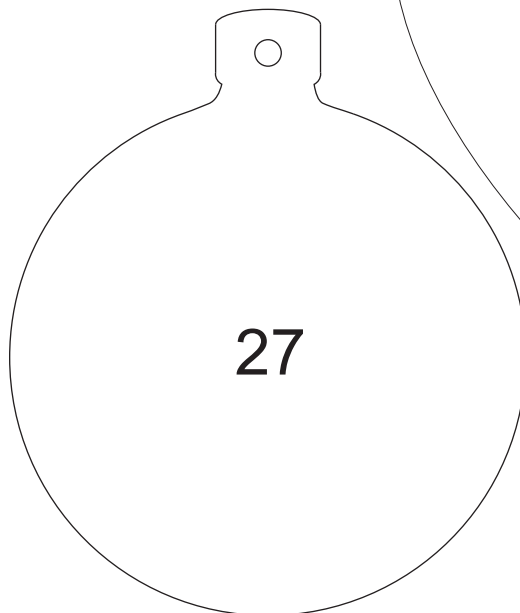
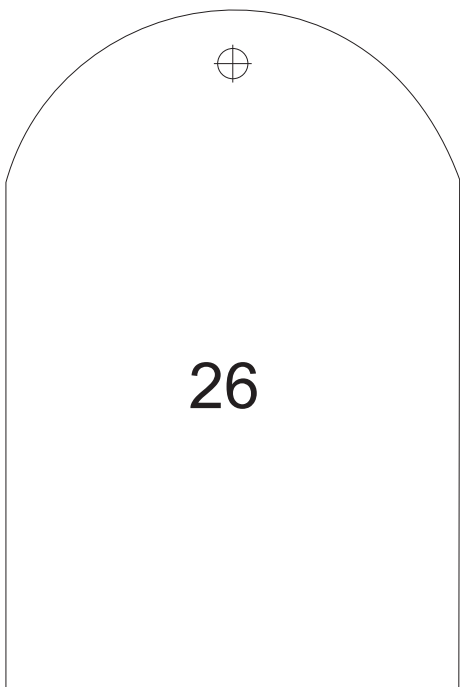
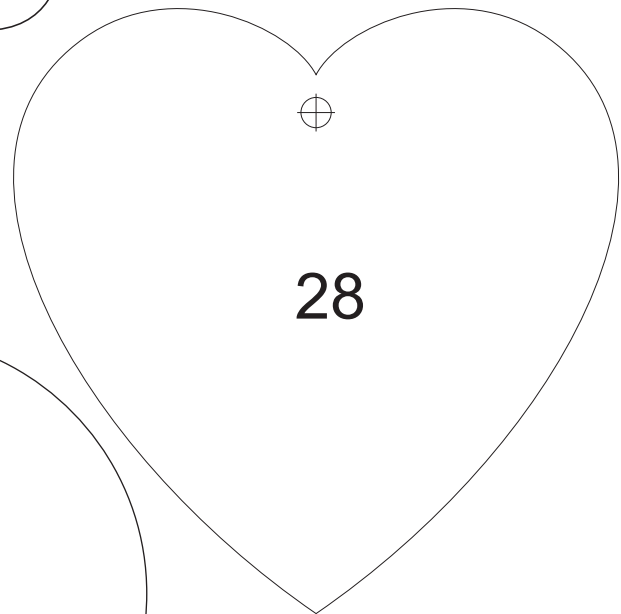
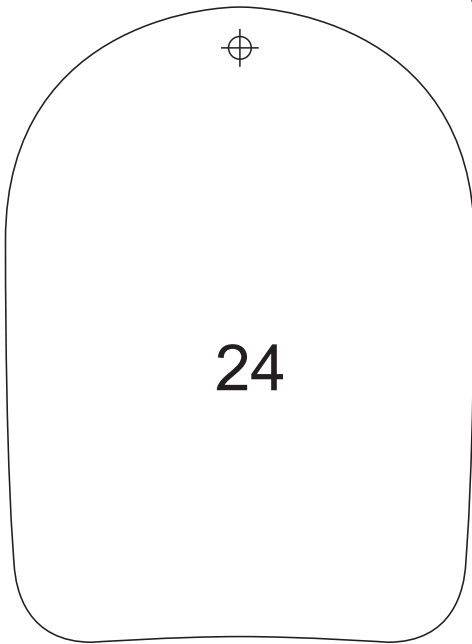
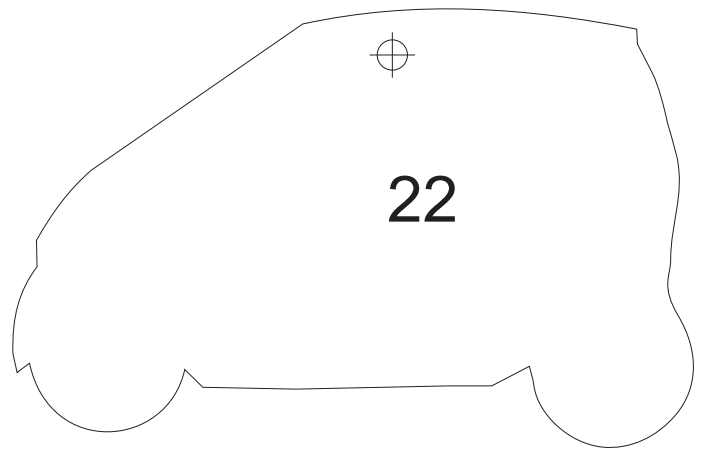
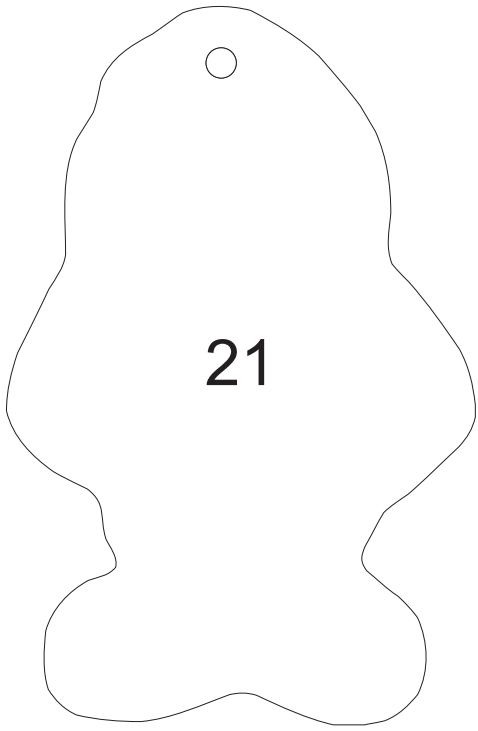

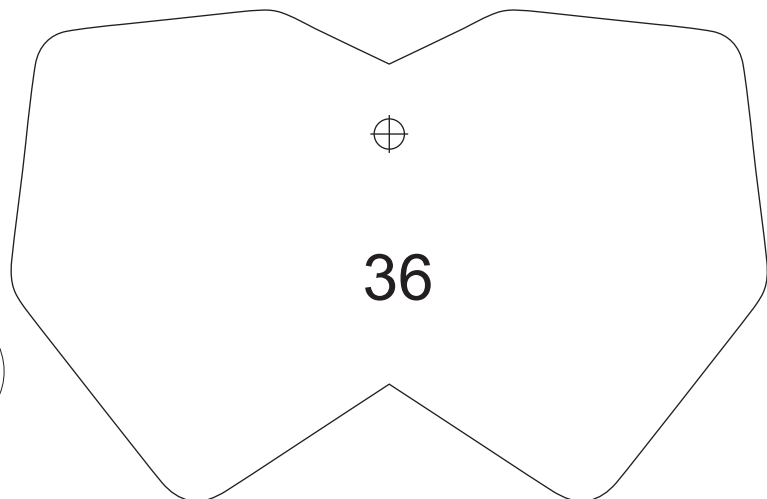
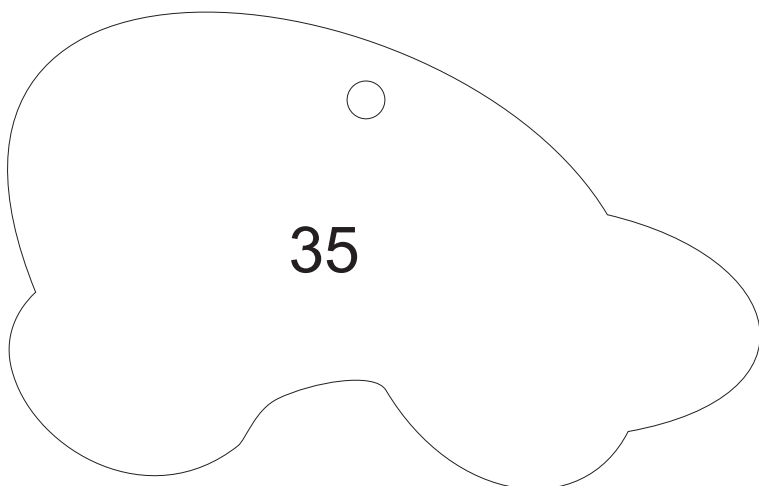
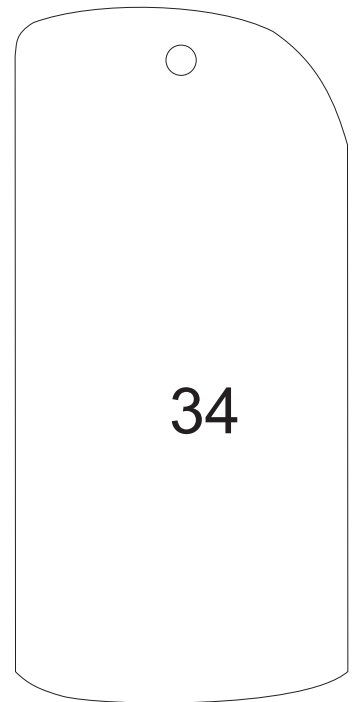
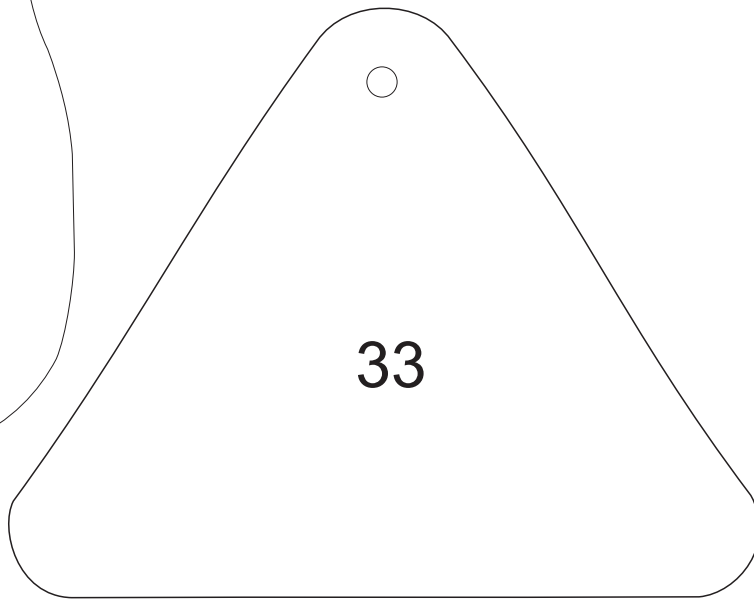
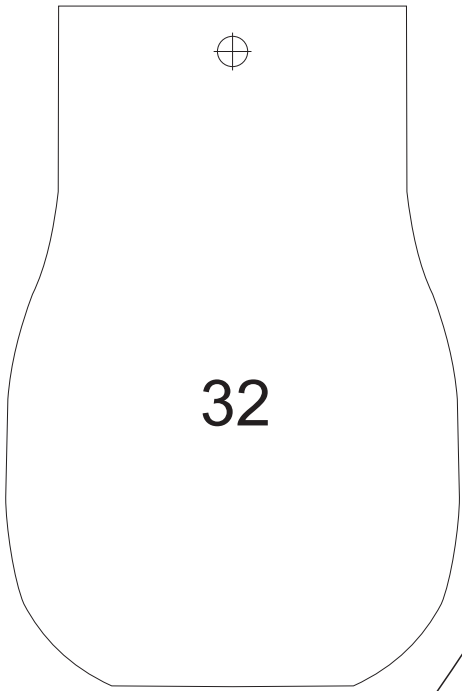
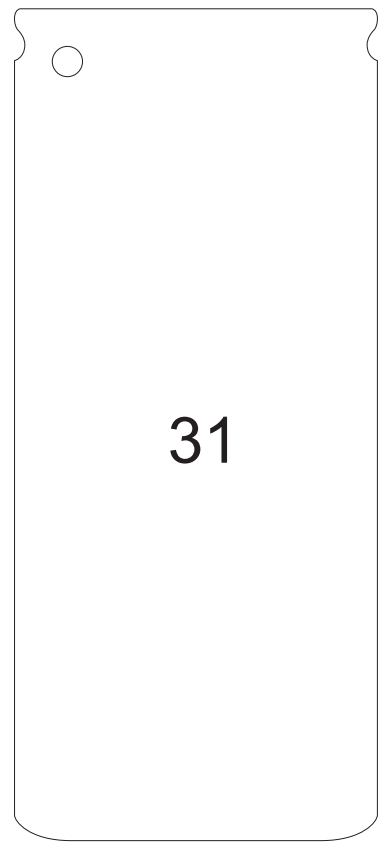
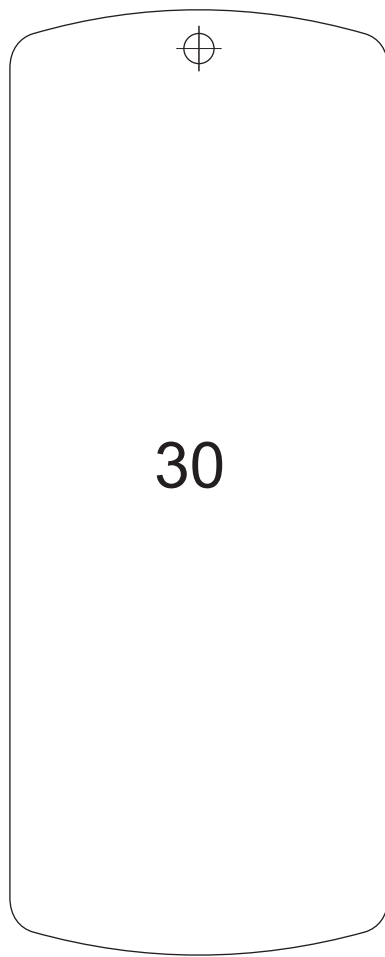
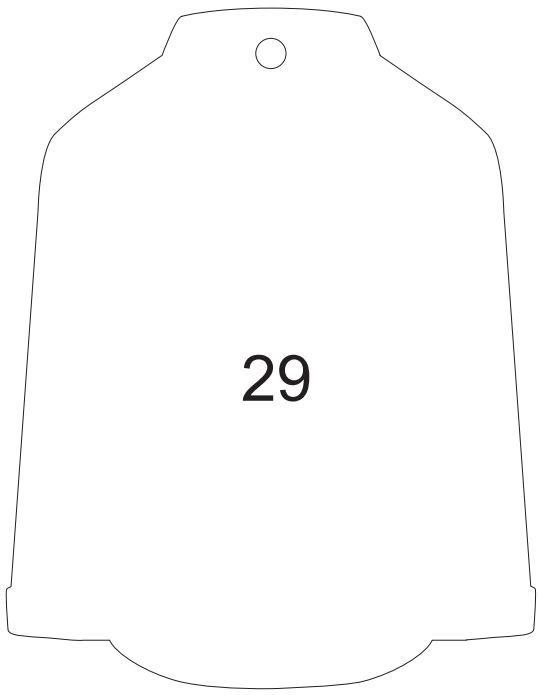

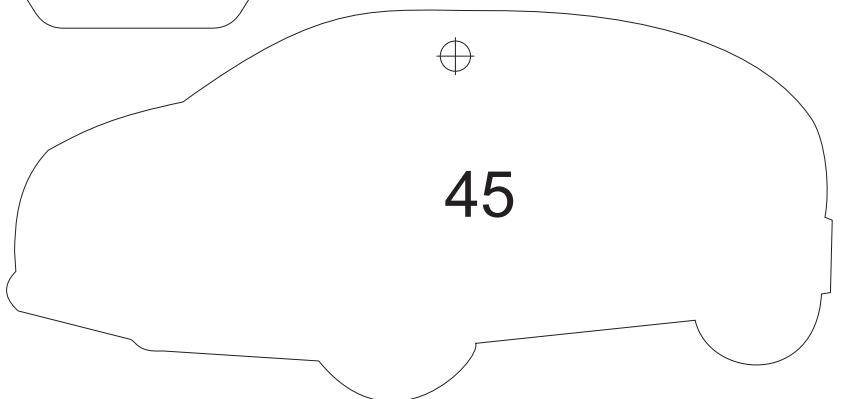
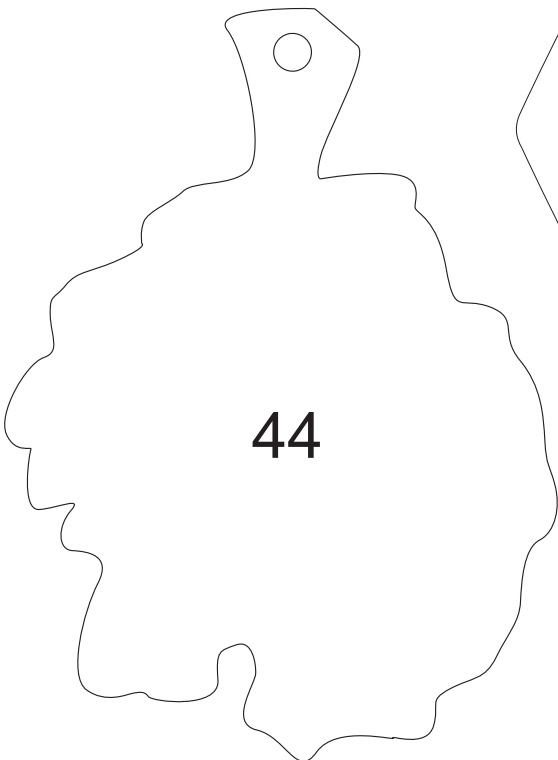
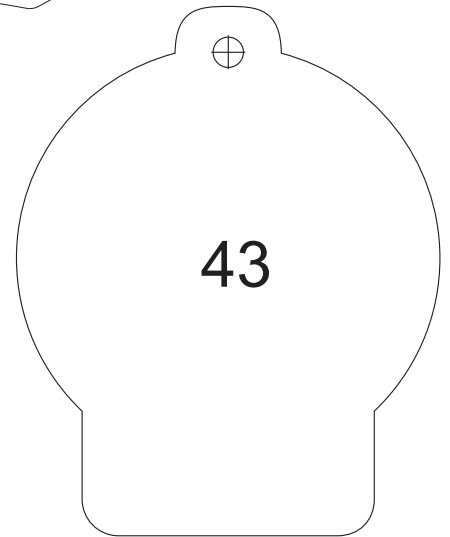
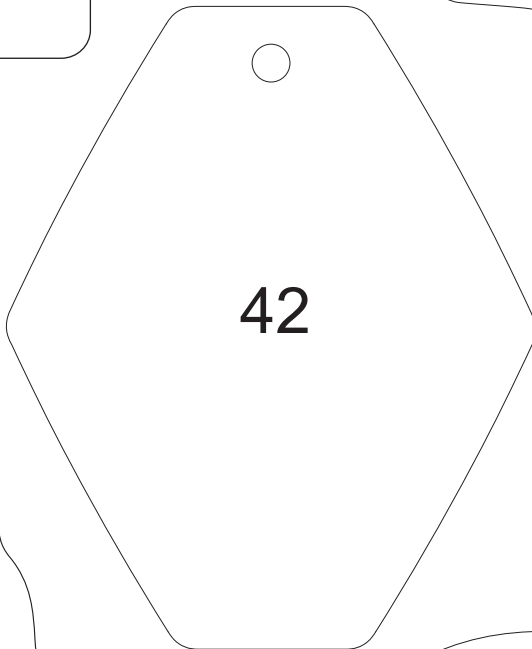
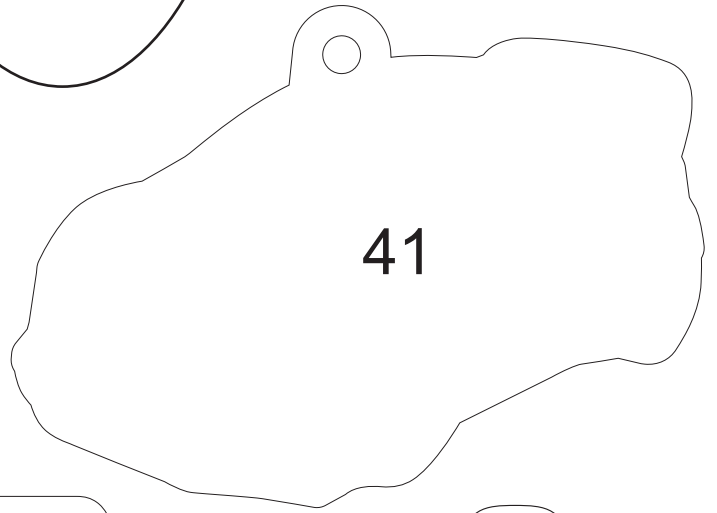
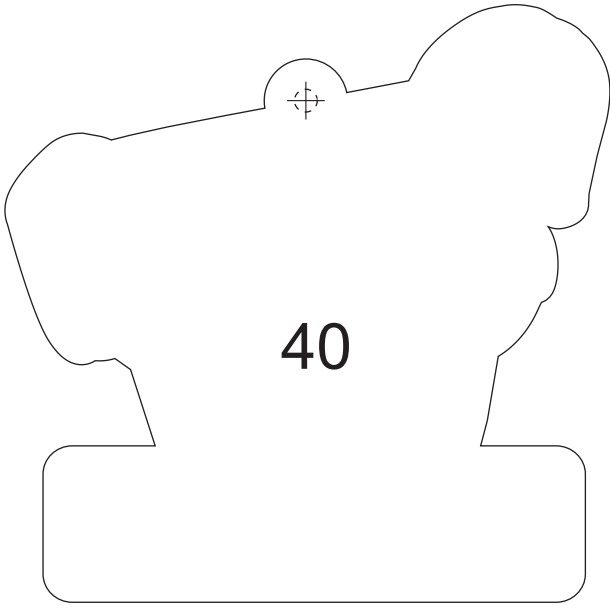
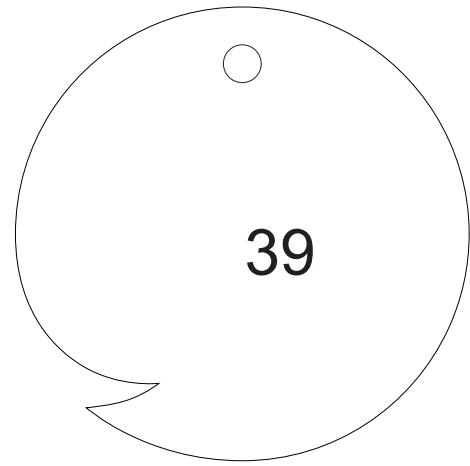
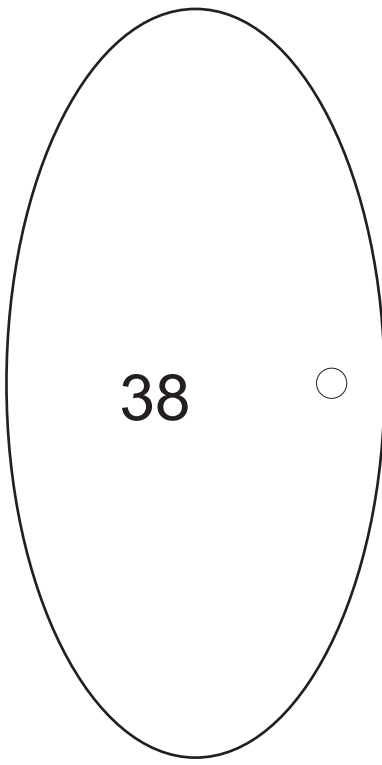
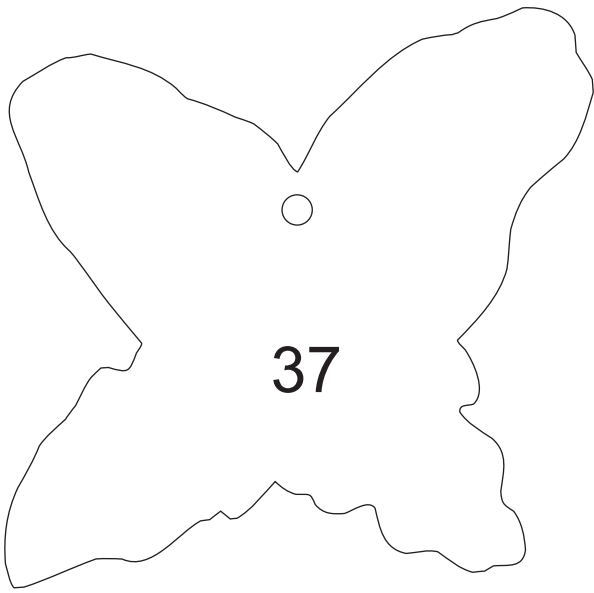

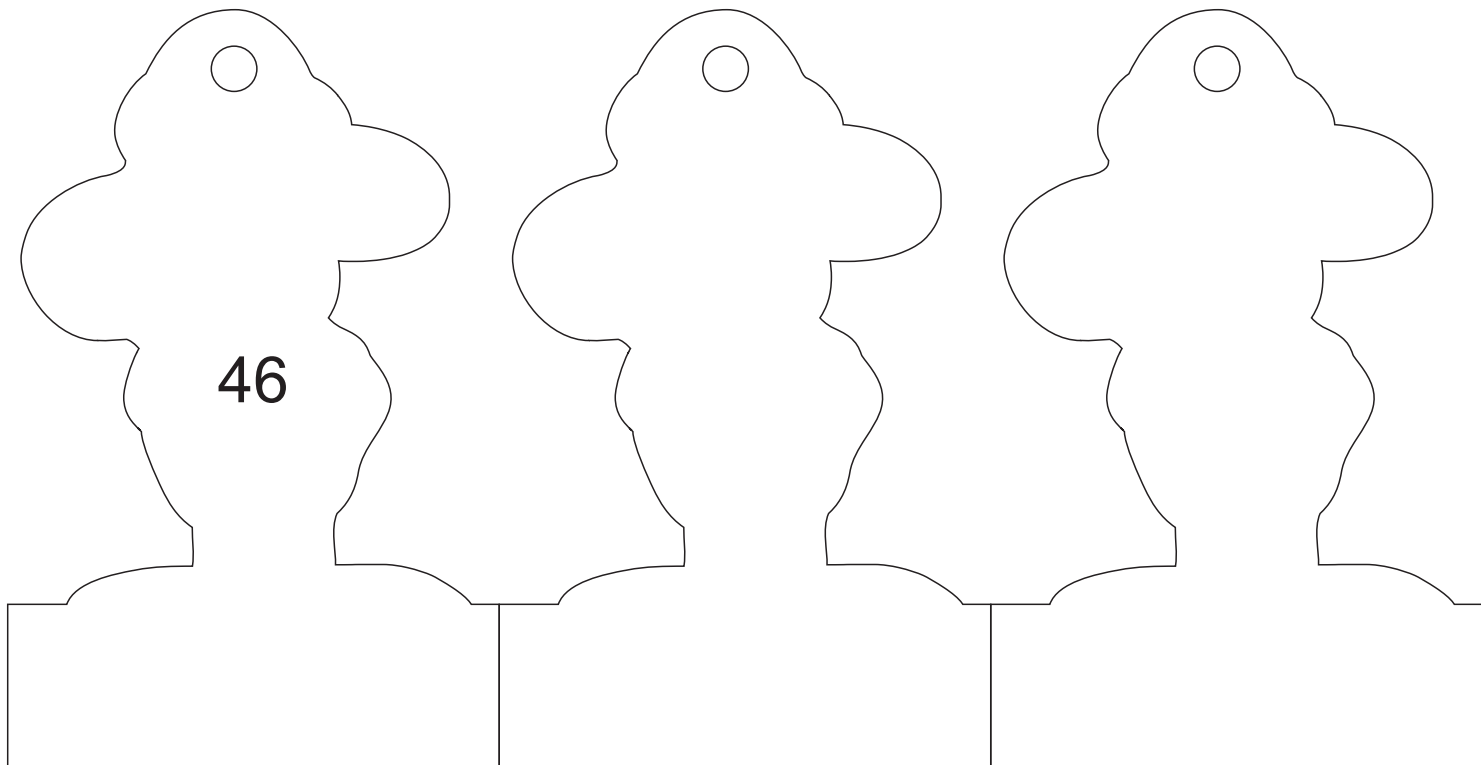

wspólny nóż

